

VersaBoard

Lightweight

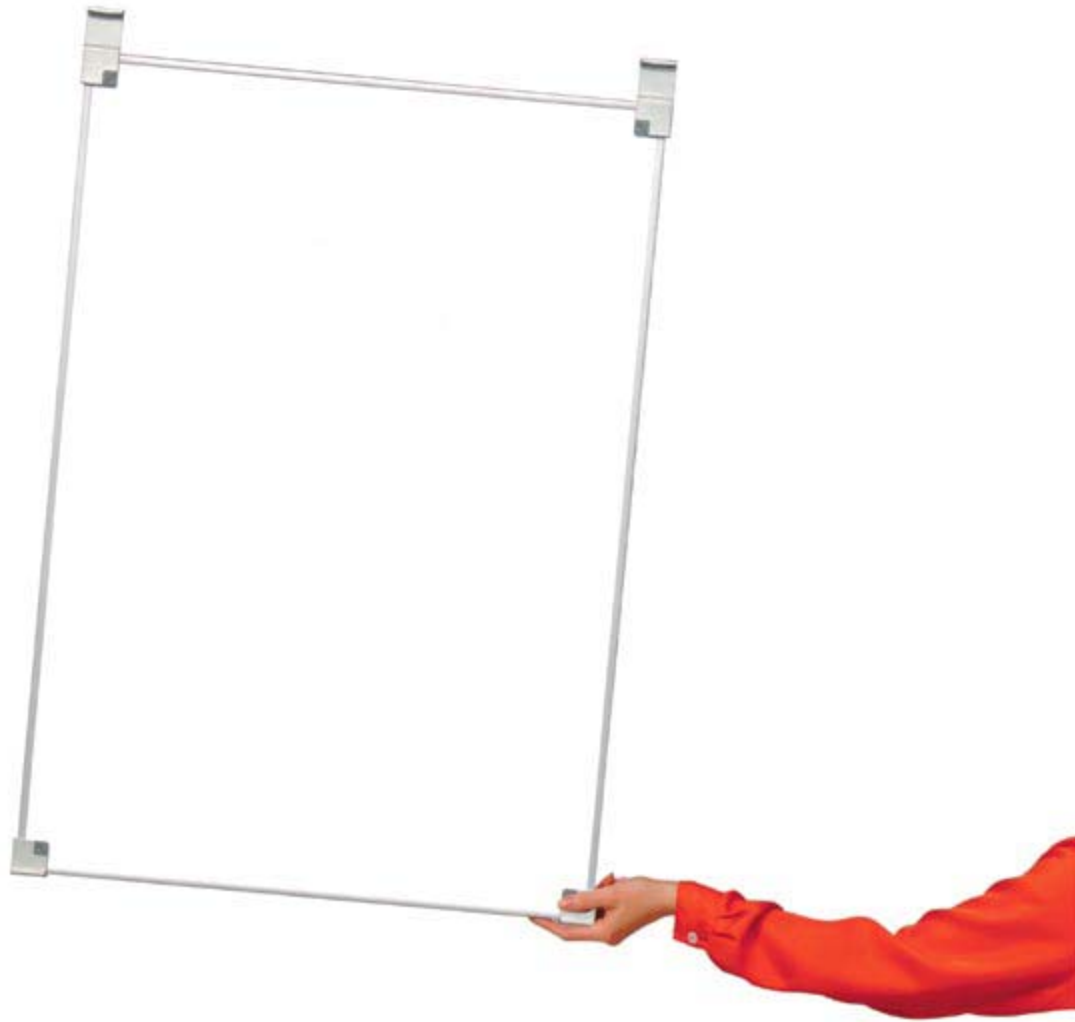

Egan VersaBoard

- Effective Communication
- Lightweight
- Versatile Mounting Options
- Guaranteed-to-clean

Versatile



Presentation Rail – yours or ours

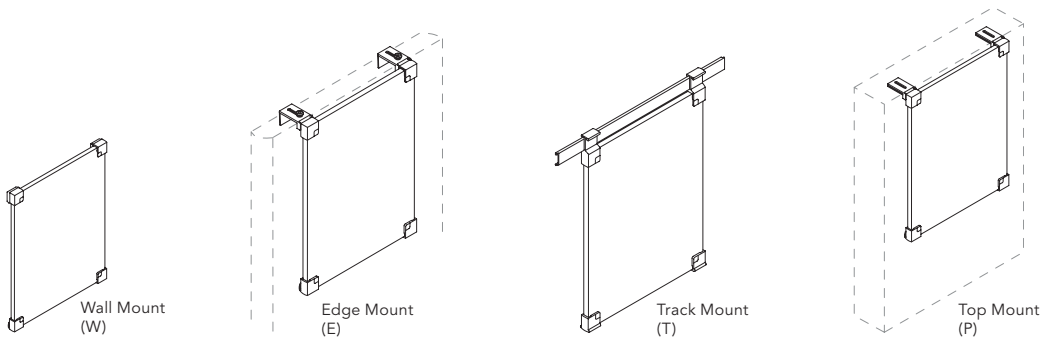

Mounting options to suit every need

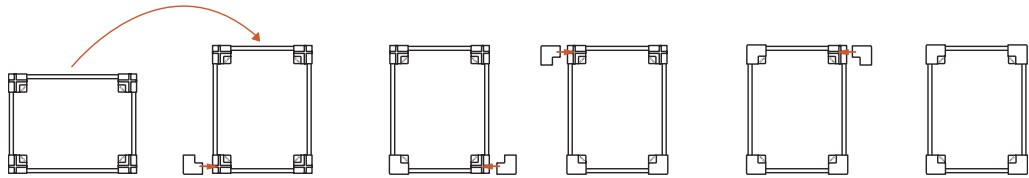

Mount horizontal, change the corner mounts, and you've got a vertical board!



Works wherever you think



Incredibly light and comfortable



Goes anywhere

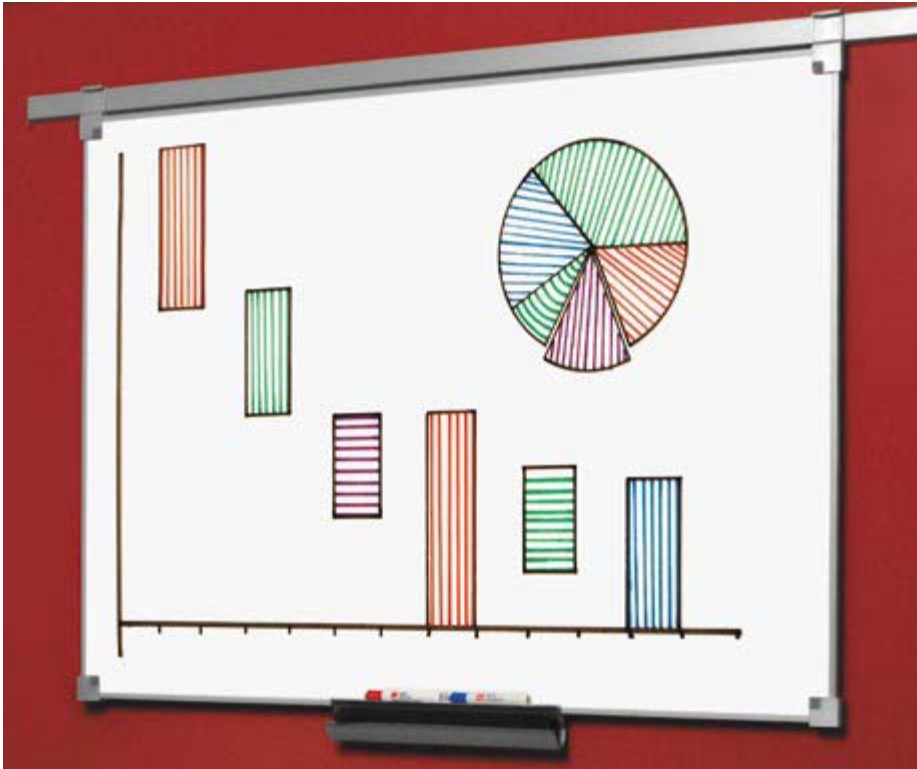

Track Mount for easy reversibility.

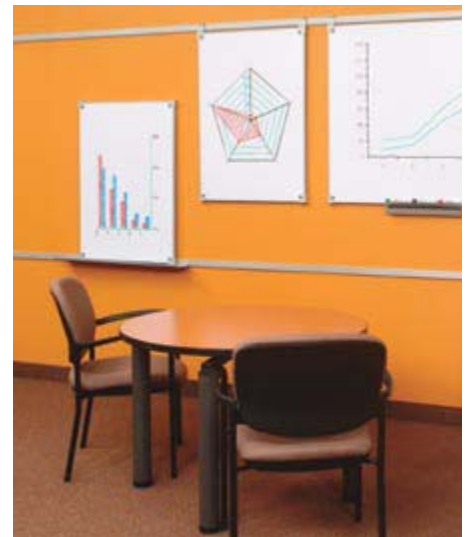

VersaBoards look great anywhere



Go ahead... storyboard, plan, create...



Track, Wall, Panel System, or Edge Mount... VersaBoards even mount on glass!



Works well with others



Cleans up real nice



Doesn't mind if you take the credit

The Egan VersaBoard Really Gets Around

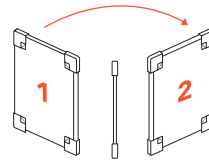
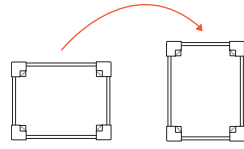

26" x 36" and 36" x 48" VersaBoards:
Horizontal to vertical in less than a minute.
Portrait to capture notes, landscape to project.

VersaBoards are double-sided.
Just flip the VersaBoard over to use the other side!

Drawings are not to scale. Corner mounts have been exaggerated for demonstration purposes only.

Extremely Light. The daring stunts pictured here are REAL (no strings attached). The VersaBoard is so incredibly lightweight, **you can lift it with your finger.**

Egan VersaBoards

- EVB2636 26" x 36" **only 3-1/2 lbs**
- EVB3648 36" x 48" **only 6-1/2 lbs**



Extremely Versatile. It doesn't matter how you hang it – wide or long (portrait or landscape), front or back (yes, it has **two sides**) – this whiteboard is extremely versatile. The VersaBoard has no fear, it hangs anywhere: on the wall, on a track, in your cubicle, on a ledge, on a file cabinet... it even mounts on glass.

Extremely Visual. The matte-white **writing/projection** surface provides a comfortable 160° viewing angle, free from hot spots or glare, without dimming the lights.



Instant Ship

VersaBoards are available on our Instant Ship Program, quantity orders ship within 10 days. See price list for details.

The Egan Dust-Free Whiteboard Solution



Egan has developed next-generation whiteboard tools to address current professional demands. The unequalled EVS surface, teamed with high-quality Egan Markers and the amazing EganCloth, equals fantastic, dust-free whiteboard performance.

For best results, always use quality, dry-erase Egan Markers and an EganCloth. EVS is available on a variety of Egan products. Refer to current price and specification guides or visit www.egan.com for details.



The unique tool for generating, capturing and presenting ideas.

EVS is a matte-finish material, available in EVS Write or EVS Projection surface finishes and is offered on lightweight honeycomb, steel (accepts magnetic accessories) or SmoothMount EganWall laminations. EVS is guaranteed to clean and offers high-performance durability.

Honeycomb Core



Take the EVS Test-Drive

1. Write on the EVS surface with a dry-erase marker.
2. Wait a minute, then erase. Use the amazing EganCloth for the best results... it eliminates ghosting and dry-erase dust.
3. If you used a permanent marker by mistake, grab a dry-erase marker and use it to scribble directly over the permanent marking, then just wipe it clean.
4. EVS Projection also features a low-gloss surface that is ideal for projection.