

EganSystem

Effective Communication



Writing & Projection Surfaces

- EVS™
- EganBoard Porcelain
- Contemporary Track System
- Versatile Design
- Shown Actual Size



Optional Bumper
Pentray

Lightweight Egan VersaBoard

- 26" w x 36" h – 3-1/2 lbs
- 36" w x 48" h – 6-1/2 lbs
- EVS, both sides
- Orients to portrait or landscape
- Top, edge, and wall mounting clips are available



Clip-on Pentray
Includes EganCloth,
brown and black
EganMarkers

EganSystem 202 Markerboard

EVS Write Surface

- 60" w x 48" h, single-sided
- Reversible, both sides available in EVS, EganBoard Porcelain, or PermaGrid Porcelain
- Orients to portrait or landscape
- Optional tackable fabric
- 36" w x 48" h
- Charcoal, EganMetallic, or Putty color frames. Custom color available
- Accepts magnetic accessories

EVS Presentation Surface, single-sided

- 60" w x 48" h
- 72" w x 54" h

**EganSystem Track
with Board – Actual Size**

EganSystem 202 mounts to any wall and it only 1-3/4" thick.





EganSystem 202 Tackboard

- 36" w x 48" h
- Reversible, optional EVS, Porcelain and tackable fabric combinations
- Orients to portrait or landscape
- Charcoal, EganMetallic, or Putty color frames. Custom color available

Magnetic Adjustable Flipchart Holder

- Adjustable mounting pins
- Accepts all Egan Flipchart Pads
- Mounts to any steel surface
- Affixes to Flipchart Assembly
- Stainless steel only

Flipchart Assembly

- Permanently mounted to a 36" w x 48" h panel
- Panel choice of EVS Magnetic or Porcelain



Instant Ship

EganSystem 202 boards are available with two business day shipping - quantity orders ship within 10 days. See price list for details.



**Optional EganMetallic
EganSystem Trim Kit
for EganWall**

**Quality
Projection
Surface**

Presentation Rail

- 36", 48", 60" widths
- Clear anodized or custom color available

Project on EganWall
160° comfortable viewing angle.



Instant Ship

EganSystem 202 boards are available with two business day shipping - quantity orders ship within 10 days. See price list for details.

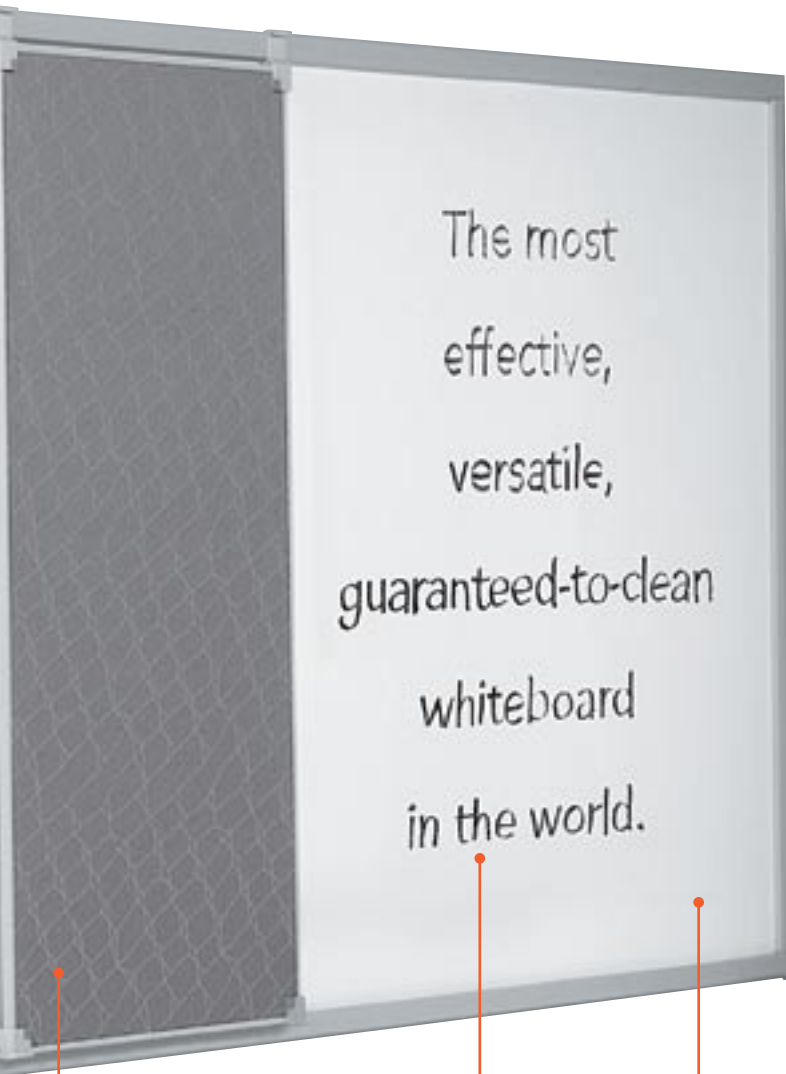

EganWall + EganSystem 202 – An Unparalleled Communication Solution

Double-sided EganSystem 202 boards combine with EganWall to provide three layers of communication surface, in less than 1-1/2 inches of depth.

- Ideal for dry-erase markerboard and projection applications, all in one.
- Installs smoothly over most wall situations.
- Reduces small indentations and minor imperfections in the supporting wall finish to provide a superior presentation surface.
- Optional EganWall Trim Kits offer a contemporary frame compatible with EganSystem Track components.
- EganWall available worldwide from wallcovering professionals.



EganWall 202 Tackboard

- EVS Write or Tackboard reversible
- 26" w x 48" h
- 26" w x 54" h
- 36" w x 48" h
- 36" w x 54" h

Quality Dry-erase Surface

EganWall Presentation – EWP

- 54" h, 20' w illustrated
- 48" h available



EganSystem Lower Track with Presentation Rail – Actual Size

Add support for presentation tools and materials.



The image shows a blue office cabinet mounted on a wall. The cabinet has a light blue left door and a darker blue right door with a silver lock. To the right of the cabinet is a shelf unit with two shelves. The top shelf holds several books, including one titled 'Need Cookbook'. The bottom shelf holds a box labeled 'Windows XP' and three blue folders. A red line points from the top left corner of the cabinet to the 'Security Lock' text. Another red line points from the bottom right corner of the cabinet to the 'EganSystem Office Cabinets' text. A third red line points from the right side of the shelf unit to the 'EganSystem Shelf' text. In the foreground, a blue desk holds a CD-ROM case and a black mousepad. A black office chair is partially visible in the bottom right corner.

Security Lock

- Approved for California state installations (OSHPD)
- Secures product to track, even under seismic activity
- Prevents unwanted movement.

EganSystem Office Cabinets

- 2 shelves, 29" h
- 3 shelves, 43" h
- 36" w
- Optional lockable doors

EganSystem Shelf

- 1 shelf, 16" h
- 2 shelves, 29" h
- 3 shelves, 43" h
- 36" w, 42" w, or 48" w



EganSystem Office Markerboards and Tackboards

- 36" w x 29" h or 42" w x 43" h
- EVS or tackable fabric surface

Configuring Track Components with EganSystem 202

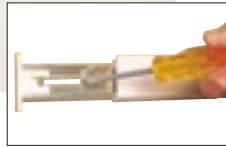
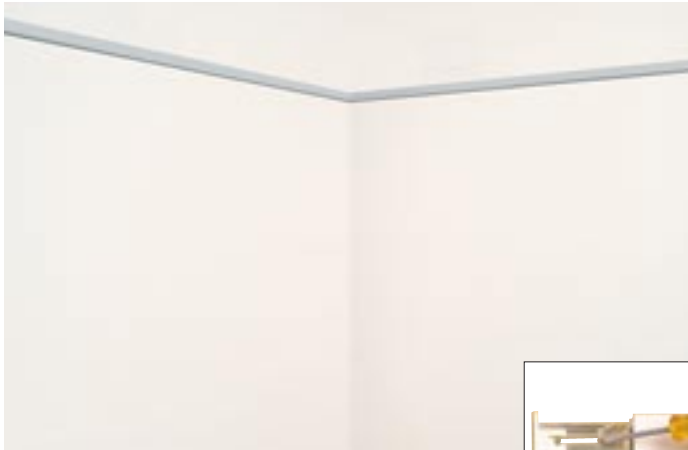

1 – Install Top Track at Desired Height

- Easy installation
- Recommended height: 81"
- Components easily suspend from track
- Easily re-configured
- GripTrack option includes built-in paper holder



2 – Enhance with Lower Track

- Recommended height: 29"
- Supports Presentation Rails shown or Reference Shelves (see below)



3 – Re-configure as an Office

- Unique track solution
- Track distributes weight
- Saves floor and desk space
- With GripTrack and Security Locks, shelves will swing, but are prevented from lifting off the track
- California State Office of Statewide Health Planning and Development (OSHPD) approved



Instant Ship

EganSystem 202 boards are available with two business day shipping - quantity orders ship within 10 days. See price list for details.



Private office move completed.

Moments to Change

Within minutes, EganSystem Office lifts off the track. Transit from office to office is a simple task, requiring minimal time and personnel.

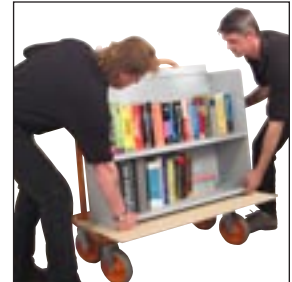

Moments to Move

- Easier than a box move.
- Faster than overnight.
- Valuable dry-erase notes are preserved.
- No need to pack/unpack shelves.



Private office, ready to move.

EganSystem 202 – Intelligent Design



How EganSystem Track Works:

- Track mount corners have a precision molded hanger
- Couples with the track for secure suspension
- Freely slides into position
- To remove, swing the board out from the bottom and lift up.

Honeycomb Core

- Recycled paper products are constructed into a honeycomb core to create durable, lightweight products.
- EVS surface results in an unbelievably lightweight whiteboard.



EganSystem Boards are double-sided

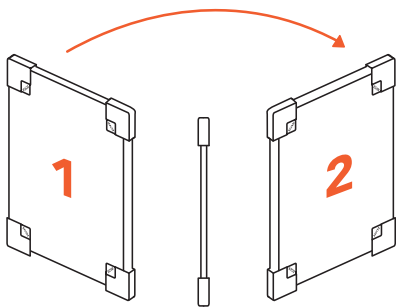

- Choice of writing surface
- Choice of tackable fabrics
- Combine EVS Write/EVS Write
- Combine EVS Write/Tackable Fabric
- Combine Porcelain/Porcelain
- Combine Porcelain/PermaGrid
- Combine Porcelain/Tackable Fabric

Portrait or landscape in seconds

- Slide track hangers and bumpers off
- Re-orient board and re-install corners

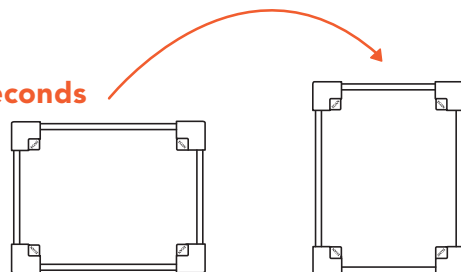

EganSystem Track – Four Track Options

Sheer Strength

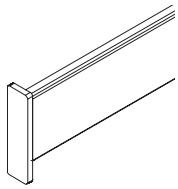

EganSystem Track

- Suitable for top or lower track
- 8' lengths
- Can be field cut to desired length
- EganMetallic, Charcoal, or Putty finish

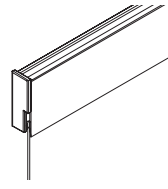

EganSystem GripTrack

- Integrated paper holder suspends flipchart sheets directly from the track.
- 8' lengths.
- Can be field cut to desired length.
- EganMetallic, Charcoal, or Putty finish.

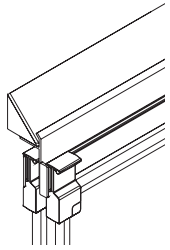

EganSystem TwinTrack

- 10' lengths, holds up to five panels.
- Ships with 5 impact-resistant bumper guides that prevent movement when using the front panel.
- Can be factory cut to specific lengths, contact factory for details.
- Contact factory for product compatibility details.

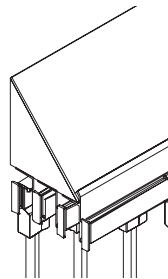

EganSystem MultiTrack

- Holds up to five panels per 10' length.
- Ships with 5 impact-resistant bumper guides that prevent movement when using the front panel.
- Can be factory cut to specific lengths, contact factory for details.
- Contact factory for product compatibility details.

EganSystem Products Add Power To Your Presentation Experience

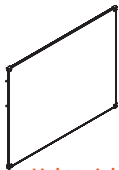

Lightweight EVS Presentation Markerboard

- 60" w x 48" h
- 72" w x 54" h
- Corner or flat mount at two heights with EVS Presentation on one side

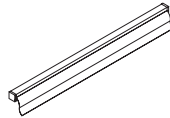

Track Mount Retractable Projection Screen

- 60" wide
- Suspends directly from System Track.

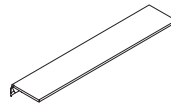

Reference Shelf

- 36", 48", 60", and 72" widths
- Etex, wood veneer, or custom color shelf
- 12" deep

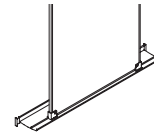

Presentation Rail

- 36", 48", 60" widths
- Clear anodized or custom color available
- 5" deep



Adjustable Magnetic Flipchart Holder

- Accepts all Egan Flipchart pads.
- Magnetic mounts
- Stainless steel only.

Accessories

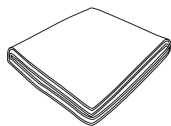

EganCloth

- Eliminates dry-erase dust
- 16" x 12"
- Available in 12-packs



EganMarkers

- High quality dry-erase CMI-AP certified
- Green, Red, Brown or Black

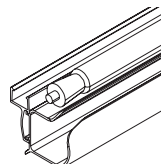

EganCloth Caddy

- Magnetic
- Clip-on

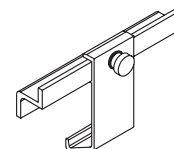

EganSystem Security Lock



Mobile Storage Cart

- 40" w x 37" h x 14" d
- Holds up to 8 EganSystem boards.

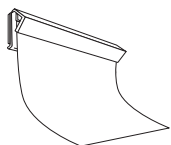

EganGrip Paper Holder

- Mounts: Magnetic, Adhesive, Plate, Top, or System
- 21.5", 33.5", 45.5", 57.5", 69.5", 93.5" widths available

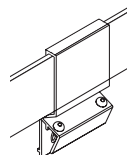

Friction Grip

- 1.5" wide
- Holds a single sheet

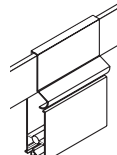

Variable Tension Grip

- 3" or 10" wide
- Holds up to 1/4" thick

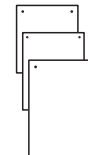

Flipchart Pads

- 27" w x 34" h
- 50 sheets, 5-pack

Your walls have never looked so good

Guaranteed-to-clean Surface Options

EganSystem EVS Markerboards are available with EVS Magnetic dry-erase surface or EganBoard Porcelain. (See below for details on EVS).

Boards are double-sided and can be specified in any combination of EVS, Fabric, EganBoard, and PermaGrid.



EVS Write (E)



EVS Presentation (P)



EganBoard Porcelain



PermaGrid Porcelain (PG)

EVS Write has a matte-white finish with a gloss value of 40°.

EVS Presentation surface has a matte-white finish with a gloss value of 30°. A 60° Gloss Meter was used to establish above values.

EganBoard Porcelain has a gloss value of 65°. EVS and EganBoard Porcelain have slightly different shades of white. When installed side-by-side, the difference in hue is noticeable.



Egan Tackable Fabric

EganSystem 202 Tackboards are standard in EganFabric, a stable polyester fabric, in a neutral color that compliments the full range of standard and Custom Color finish choices.



Egan has a synergy program with Maharam Fabrics offering thousands of optional tackable fabrics.

C.O.M. (Customer's Own Material) requirements may be coordinated through Customer Service. A sample is required for approval prior to order acceptance. See Egan's current 'Price & Specification Guide' for details.



V-Series Mobile Markerboard



A-Frame VersaMobile

Egan Mobile Markerboards

V-Series Markerboards

- Accepts magnetic mounted EganSystem Track for lightweight VersaBoards only

A-Frame VersaMobiles

- Track mount on both sides
- Storage for up to five 36" w x 48" h systemboards



EganSystem standard in EganMetallic, Charcoal, and Putty. Custom color available.



The unique tool for generating, capturing and presenting ideas.

EVS is a matte-finish material, available in EVS Write or EVS Presentation surface finishes and is offered on lightweight honeycomb, steel (accepts magnetic accessories) or SmoothMount EganWall laminations. EVS is guaranteed to clean and offers high-performance durability.

Honeycomb Core



1



2



3



4

Take the EVS Test-Drive

1. Write on the EVS surface with a dry-erase marker.
2. Wait a minute, then erase. Use the amazing EganCloth for the best results... it eliminates ghosting and dry-erase dust.
3. If a permanent marker is used by mistake, grab a dry-erase marker and scribble directly over the permanent marking, then just wipe it clean.
4. EVS Presentation also features a low-gloss surface ideal for projection.



Egan Visual, Inc.
U.S. Eastern/Central States and Canada

905-851-2826 or 1-800-263-2387
Fax 905-851-3426 or 1-888-609-8886
evi@egan.com

Egan Visual/West, Inc.
U.S. Mountain and Western States

1-800-826-1778 or 323-720-1336
Fax 800-826-1778 or 323-720-1911
evw@egan.com

www.egan.com